

LOGO SEAL REVERSED

Volume 19, Issue 5  
January 17, 2022

**We Remember:**



# Results: CEOs

Team Name	Total	10	13	14	8	11	7	16	9	15	4	3	12	6	5	1	2
10. Naren Gupta Team	195.30		7.17	7.17	10.00	13.72	14.80	18.84	15.05	12.83	14.80	12.83	15.52	6.57	14.28	13.14	18.58
13. Rasmussen	188.55	12.83		13.43	3.22	15.29	14.00	16.59	10.39	17.51	19.44	12.83	0.78	11.50	5.72	17.51	17.51
14. Rosenthal	178.87	12.83	6.57		6.57	16.97	9.61	4.48	16.97	12.18	5.20	19.96	16.18	15.75	9.23	17.51	8.86
8. Lo	167.42	10.00	16.78	13.43		9.61	4.48	4.48	12.18	16.39	9.23	19.22	2.16	13.43	18.00	12.83	5.20
11. Nickell	165.08	6.28	4.71	3.03	10.39		8.86	12.18	12.51	6.00	19.33	16.97	6.00	11.14	17.34	15.29	15.05
7. Hill	158.32	5.20	6.00	10.39	15.52	11.14		2.66	8.86	15.29	9.23	6.00	14.80	16.18	7.82	9.23	20.00
16. Zhang	150.78	1.16	3.41	15.52	15.52	7.82	17.34		15.97	0.00	2.84	10.77	10.39	14.28	9.61	8.15	18.00
9. Lusky	148.03	4.95	9.61	3.03	7.82	7.49	11.14	4.03		14.80	6.28	8.86	16.78	15.75	12.83	15.05	9.61
15. Xiao	147.04	7.17	2.49	7.82	3.61	14.00	4.71	20.00	5.20		19.55	8.86	18.30	15.52	0.56	14.54	4.71
4. Bishel	140.86	5.20	0.56	14.80	10.77	0.67	10.77	17.16	13.72	0.45		1.56	11.50	10.39	17.34	12.83	13.14
3. Beatty	135.20	7.17	7.17	0.04	0.78	3.03	14.00	9.23	11.14	11.14	18.44		10.39	0.56	17.16	4.95	20.00
12. Parker	131.98	4.48	19.22	3.82	17.84	14.00	5.20	9.61	3.22	1.70	8.50	9.61		9.61	5.46	13.43	6.28
6. Fox	130.75	13.43	8.50	4.25	6.57	8.86	3.82	5.72	4.25	4.48	9.61	19.44	10.39		11.14	6.86	13.43
5. Carmichael	130.06	5.72	14.28	10.77	2.00	2.66	12.18	10.39	7.17	19.44	2.66	2.84	14.54	8.86		13.14	3.41
1. Bacon	123.22	6.86	2.49	2.49	7.17	4.71	10.77	11.85	4.95	5.46	7.17	15.05	6.57	13.14	6.86		17.68
2. Bauer	108.54	1.42	2.49	11.14	14.80	4.95	0.00	2.00	10.39	15.29	6.86	0.00	13.72	6.57	16.59	2.32	

- USBF President**  
Aaron Silverstein
- USBF Vice President**  
Lynn Baker
- USBF COO & Secretary**  
Jan Martel
- USBF CFO**  
Stan Subeck
- USBF Recorder**  
Jack Oest
- Director**  
McKenzie Myers
- Tournament Organizer**  
Jan Martel
- Software Expert**  
Al Hollander
- Online VuGraph Organizer**  
Chris Wiegand
- Appeals Administrators**  
Suzi Subeck, Chairman
- Appeals Panel:**  
Rich DeMartino  
Marty Fleisher  
Ron Gerard  
Marty Hirschman  
George Jacobs  
Danny Sprung  
Joann Sprung  
Josh Stark  
Stan Subeck  
Adam Wildavsky

# Mayors

Team Name	Total	33	22	29	30	25	21	27	31	35	34	28	23	32	24	26	36
33. Rosenberg	193.24		15.29	7.49	13.72	4.25	13.14	12.18	15.75	10.77	16.39	15.05	13.72	14.28	6.28	16.78	18.15
22. Bramley	190.99	3.71		4.95	8.86	10.00	20.00	10.00	13.14	15.75	16.59	2.66	13.43	15.52	17.68	18.84	19.86
29. Lall	173.55	12.51	15.05		3.03	12.83	1.56	16.59	13.43	13.43	4.95	2.66	16.18	14.00	14.80	16.78	15.75
30. Levine	167.99	6.28	11.14	16.97		17.16	0.00	4.48	6.28	15.97	11.85	11.50	19.00	4.71	16.39	12.83	13.43
25. Dawson	166.64	15.75	10.00	7.17	2.84		14.54	7.82	7.82	2.32	15.75	18.58	18.71	15.05	13.43	10.00	6.86
21. Baseggio	162.20	6.86	0.00	18.44	20.00	5.46		10.00	3.41	8.86	13.72	11.50	2.49	10.39	16.59	16.97	17.51
27. Donner	158.10	7.82	10.00	3.41	15.52	12.18	10.00		6.86	9.61	13.43	19.55	17.84	8.86	4.95	6.57	11.50
31. Lewis	155.97	4.25	6.86	6.57	13.72	12.18	16.59	13.14		15.52	16.78	10.39	6.28	15.05	0.14	16.18	2.32
35. Tebha	152.30	9.23	4.25	6.57	4.03	17.68	11.14	10.39	4.48		5.20	18.97	1.85	13.14	15.29	11.50	18.58
34. Stokes	138.32	3.61	3.41	15.05	8.15	4.25	6.28	6.57	3.22	14.80		16.59	5.20	13.14	11.50	12.83	13.72
28. Greenspan	131.73	4.95	17.34	17.34	8.50	1.42	8.50	0.45	9.61	1.03	3.41		15.75	18.15	18.71	4.25	2.32
23. Brines	130.92	6.28	6.57	3.82	0.00	1.29	17.51	2.16	13.72	18.15	14.80	4.25		1.56	9.23	14.80	16.78
32. Reynolds	130.32	5.72	4.48	6.00	15.29	4.95	9.61	11.14	4.95	6.86	6.86	1.85	18.44		13.14	16.78	4.25
24. Cappelli	120.00	13.72	2.32	5.20	3.61	6.57	3.41	15.05	19.86	4.71	8.50	1.29	10.77	6.86		6.28	11.85
26. Donnelly	114.13	3.22	1.16	3.22	7.17	10.00	3.03	13.43	3.82	8.50	7.17	15.75	5.20	3.22	13.72		15.52
36. Vance	111.60	1.85	0.14	4.25	6.57	13.14	2.49	8.50	17.68	1.42	6.28	17.68	3.22	15.75	8.15	4.48	

- Bulletin Editor**  
Suzi Subeck
- Photographer**  
Peg Kaplan

# Teams Entered...

J LALLS

There are 32 teams entered and listed in alphabetic order.

Bacon	John Bacon, Capt Fred Schenker Stelian Hritcu	Bernie Greenspan Ken Kranyak
Baseggio	Franco Baseggio, Capt Jeff Roman Alex Kolesnik	Andy Stark Ralph Buchalter Steve Price
Bauer	Tracey Bauer, Capt John McAllister	Nicolas Hammond Lilly Justman
Beatty	Steve Beatty, Capt Doug Doub Bob Blanchard	Fred Stewart Yiji Starr Bill Pollack
Bishel	Tom Bishel, Capt John Hinton	John Bishel Jerry Clerkin
Bramley	Bart Bramley, Capt Peter Boyd Chip Martel	Kit Woolsey Steve Robinson Mark Feldman
Brines	Tracy Brines, Capt Ethan Wood Peter Boyd-Bowman	Joyce Goldstein Jane McLaughlin Alix Taylor
Cappelli	Bob Cappelli, Capt Gloria Bart	Mark Aquino Les Bart
Carmichael	Tom Carmichael, Capt Jenni Carmichael	Nathan Gong Arthur Gong
Dawson	Dennis Dawson, Capt Mark Itabashi Ifti Baqai	Charlie Wilkins Disa Eythorsdottir Mitch Dunitz
Donnelly	Chris Donnelly, Capt Eric Genheimer Kyle Rockoff	Sarik Goyal Joe Veal Daniel Weiss
Donner	Gary Donner, Capt Joe Grue	Sandra Rimstedt Brad Moss Janice Molson
Fox	Jim Fox, Capt Allan Graves Wayne Stuart	Jerry Helms Neil Chambers Jon Rice
Greenspan	Jon Greenspan, Capt Glenn Eisenstein Geof Brod	Phil Benner John Rengstorff Pat McDevitt
Hill	Joyce Hill, Capt Shan Huang John Hurd	Kevin Dwyer Kevin Bathurst
Lall	Hemant Lall, Capt Brian Platnick Jim Krekorian	Reese Milner John Diamond Drew Casen
Levine	Mike Levine Jeff Meckstroth Mike Passell Bob Morris, NPC	Eddie Wold David Berkowitz Mark Lair
Lewis	Paul Lewis, Capt Ron Smith	Linda Lewis Josh Donn
Lo	Ai-Tai Lo, Capt David Yang JoAnna Stansby	David Chechelashvili Jonathan Weinstein Li-Chung Chen
Lusky	John Lusky, Capt Frank Merblum Doug Simson	Allan Falk Walter Lee Jeff Aker

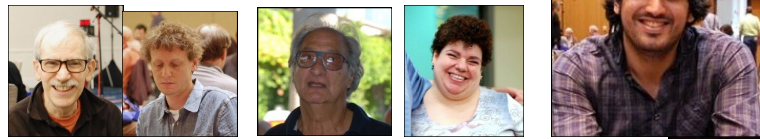

Naren Gupta Team	Vinita Gupta Daniel Korbel Michael Rosenberg Ash Gupta, NPC	Zia Mahmood Roger Lee Zach Grossack
Nickell	Nick Nickell Bobby Levin Eric Greco Jill Levin, NPC	Ralph Katz Steve Weinstein Geoff Hampson
Parker	Stewart Rubenstein, Capt Adam Grossack Joel Wooldridge	Chris Parker David Grainger
Rasmussen	Jim Rasmussen, Capt Melody Bi Maxim Silin	Anton Tsyarkin Alan Watson Carrie Liu
Reynolds	Tom Reynolds, Capt Bill Hall Randy Howard	Lance Kerr Joe Viola Hank Youngerman
Rosenberg	Kevin Rosenberg, Capt Finn Kolesnik Brent Xiao	Cynthia Huang Ish DelMonte Cornelius Duffie
Rosenthal	Andrew Rosenthal, Capt Chris Willenken Eldad Ginossar	Debbie Rosenberg Migry Campanile Dana Berkowitz
Stokes	Cheri Bjerkan, Capt Amber Lin Shawn Quinn	Emma Kolesnik Rozanne Pollack Pam Wittes
Tebha	Anam Tebha, Capt Andy Goodman Christal Henner	Steve Zolotow Craig Ganzer Uday Ivatury
Vance	Grant Vance, Capt Farid Assemi Edward Wojewoda	Jessica Lai Jim Slinger Leszek Rabięga
Xiao	Victor Xiao, Capt Jeff Xiao Yaning Zhou	Eric Xiao Dawei Qi Meiyan Duan
Zhang	Qiang Zhang, Capt Jun Shi Serena Guo	Brian Zhang Steve Chen Ethan Liu

## Brackets:

CEOS	MAYORS
Bacon	Baseggio
Bauer	Bramley
Beatty	Brines
Bishel	Cappelli
Carmichael	Dawson
Fox	Donnelly
Hill	Donner
Lo	Greenspan
Lusky	Lall
Naren Gupta Team	Levine
Nickell	Lewis
Parker	Reynolds
Rasmussen	Rosenberg
Rosenthal	Stokes
Xiao	Tebha
Zhang	Vance



# Tournament Schedule

ROUND ROBIN - STAGE 1			
DAY	DATE	TIME - EDT	BOARDS
FRIDAY	JAN 14	11:45 AM	CAPTAINS' MEETING WITH DIC (ON ZOOM)
FRIDAY	JAN 14	12:00 - 1:15	ROUND 1 - BOARDS 1-10
		1:35 - 2:50	ROUND 2 - BOARDS 11-20
		3:10 - 4:25	ROUND 3 - BOARDS 21-30 50 MINUTE BREAK
		5:15 - 6:30	ROUND 4 - BOARDS 31-40
		6:50 - 8:05	ROUND 5 - BOARDS 41-50
SATURDAY	JAN 15	12:00 - 1:15	ROUND 6 - BOARDS 51-60
		1:35 - 2:50	ROUND 7 - BOARDS 61-70
		3:10 - 4:25	ROUND 8 - BOARDS 71-80 50 MINUTE BREAK
		5:15 - 6:30	ROUND 9 - BOARDS 1-10
		6:50 - 8:05	ROUND 10 - BOARDS 11-20
SUNDAY	JAN 16	12:00 - 1:15	ROUND 11 - BOARDS 21-30
		1:35 - 2:50	ROUND 12 - BOARDS 31-40
		3:10 - 4:25	ROUND 13 - BOARDS 41-50 50 MINUTE BREAK
		5:15 - 6:30	ROUND 14 - BOARDS 51-60
		6:50 - 8:05	ROUND 15 - BOARDS 61-70
ROUND ROBIN - STAGE 2			
MONDAY	JAN 17	12:00 - 1:15	ROUND 1 - BOARDS 1-10
		1:35 - 2:50	ROUND 2 - BOARDS 11-20
		3:10 - 4:25	ROUND 3 - BOARDS 21-30 50 MINUTE BREAK
		5:15 - 6:30	ROUND 4 - BOARDS 31-40
		6:50 - 8:05	ROUND 5 - BOARDS 41-50
KO CAPTAINS' MEETING ON ZOOM			
TUESDAY	JAN 18	12:00 NOON	
ROUND OF 16			
FRIDAY	JAN 21	12:00 - 1:45	SEGMENT 1 BOARDS 1-14
		2:05 - 3:50	SEGMENT 2 BOARDS 15-28 50 MINUTE BREAK
		4:40 - 6:25	SEGMENT 3 BOARDS 29-42
		6:45 - 8:30	SEGMENT 4 BOARDS 43-56
QUARTERFINAL			
SATURDAY	JAN 22	12:00 - 1:45	SEGMENT 1 BOARDS 1-14
		2:05 - 3:50	SEGMENT 2 BOARDS 15-28 50 MINUTE BREAK
		4:40 - 6:25	SEGMENT 3 BOARDS 29-42
		6:45 - 8:30	SEGMENT 4 BOARDS 43-56
SEMIFINAL			
SUNDAY	JAN 23	12:00 - 1:45	SEGMENT 1 BOARDS 1-14
		2:05 - 3:50	SEGMENT 2 BOARDS 15-28 50 MINUTE BREAK
		4:40 - 6:25	SEGMENT 3 BOARDS 29-42
		6:45 - 8:30	SEGMENT 4 BOARDS 43-56
FINAL			
MONDAY	JAN 24	12:00 - 1:45	SEGMENT 1 BOARDS 1-14
		2:05 - 3:50	SEGMENT 2 BOARDS 15-28 50 MINUTE BREAK
		4:40 - 6:25	SEGMENT 3 BOARDS 29-42
		6:45 - 8:30	SEGMENT 4 BOARDS 43-56

# USBF 10 Board victory Point Scale

10 Boards (Blitz is 48 IMPs)								
Margin	Winner	Loser	Margin	Winner	Loser	Margin	Winner	Loser
0	10.00	10.00	17	15.29	4.71	34	18.44	1.56
1	10.39	9.61	18	15.52	4.48	35	18.58	1.42
2	10.77	9.23	19	15.75	4.25	36	18.71	1.29
3	11.14	8.86	20	15.97	4.03	37	18.84	1.16
4	11.50	8.50	21	16.18	3.82	38	18.97	1.03
5	11.85	8.15	22	16.39	3.61	39	19.10	0.90
6	12.18	7.82	23	16.59	3.41	40	19.22	0.78
7	12.51	7.49	24	16.78	3.22	41	19.33	0.67
8	12.83	7.17	25	16.97	3.03	42	19.44	0.56
9	13.14	6.86	26	17.16	2.84	43	19.55	0.45
10	13.43	6.57	27	17.34	2.66	44	19.66	0.34
11	13.72	6.28	28	17.51	2.49	45	19.76	0.24
12	14.00	6.00	29	17.68	2.32	46	19.86	0.14
13	14.28	5.72	30	17.84	2.16	47	19.96	0.04
14	14.54	5.46	31	18.00	2.00	48	20.00	0.00
15	14.80	5.20	32	18.15	1.85			
16	15.05	4.95	33	18.30	1.70			

## Ethics Statement

**Ethics** - We're not trying to provide the same security for this event as we have for online events to select USBF International teams. However, the provisions of the USBF General Conditions of Contest regarding ethical obligations and possible penalties apply to this event. The USBF has appointed an Ethics Investigation Committee that will review any complaints about ethics violations. If the EIC concludes that a player or pair was acting unethically, they will report to the USBF Board of Directors, who may place a player on probation, suspend, or expel a player for cause.

2022 Committee is: **Dana Berkowitz, Eugene Hung, Roger Lee, Chip Martel, Steve Weinstein, Jenny Wolpert**

## System Regulations & Conditions of Contest

- Normal USBF System regulations apply to this event.
- This event is governed by the USBF General Conditions of Contest and Special Conditions of Contest for this event.
- The ACBL Open+ Convention Chart applies to this event.



# Kibitzing on VuGraph...

THERE WILL BE DEFERRED KIBITZING FOR ALL OF THE JLALL5 EVENT.

KIBITZING SCHEDULE FOR THE ROUND ROBIN (EST)

The schedule will be the same each day:

**Round 1: 1:15pm**

**Round 2: 2:50 pm**

**Round 3: 4:25 pm**

**Round 4: 6:30 pm**

**Round 5: 8:05 pm**

KIBITZING SCHEDULE FOR THE KO (EST)

**Quarter 1: 12:30 pm**

**Quarter 2: 2:35 pm**

BREAK

**Quarter 3: 6:25 pm**

**Quarter 4: 8:30 pm**



Watching online,  
Even delayed,  
Is the best way to see  
How a hand's bid and played!

To kibitz, go to [the RealBridge kibitzing website](#), enter your name and click on Log In. That will take you to a screen where you can select the event to kibitz.

After you select Kibitz JLall Online Teams #5, you will be taken to a lobby with a list of tables on the left and a chat box and list of people on the right. The table listing shows the team & player names at each table, as well as the board being played. There will be information about the number of kibitzers and whether there is audio/video commentary (a picture of a TV means there is). Click on a table to kibitz it.

At the table, you will see a hand diagram, and the bidding and play as it happened.

There is a chat window on the right of the screen. You can type chat into the chat window.

Some things you can do to get more information:

If there is an asterisk next to a bid, that means it was Alerted/Explained. Click on the bid to see the explanation.

-- "Rewind" using the slider underneath the "table." Move the handle to the left to go to earlier tricks.

-- Click on the "Scores" button to the left of the South player's name to get a scorecard for the match.

----Click on a board number to see the hand record and results at all of the tables.

----You can also click on a number in a yellow box to get to the hand record from some screens.

----In the hand record screen, click on a result to see the bidding and play at a specific table.

--In the upper left corner:

----Click on the yellow box with 4 little boxes to get the match scores for all the matches (that will be IMPs and for the Round Robin will not include scores from previous rounds).

----Click on the yellow box with 3 bulleted lines to get Cross-IMPs for the pairs (that will be just for this match).

The Scores information is also available in the lobby using the button at the upper right should you want to check on scores before deciding which table to watch.

## TIMING OF DEFERRAL

The Round Robin matches will be deferred until each round is completed.

The first half KO matches will be deferred for half an hour or until each board has been played at all tables, so there may sometimes be a period when nothing new is being shown because one or two tables are very slow to play the board. **For the second half of the KO matches, the delay will be until the quarter is scheduled to be completed, so players will not be able to get useful state of match information. That means that the 3rd quarter kibitzing will start at 6:25 EST.**

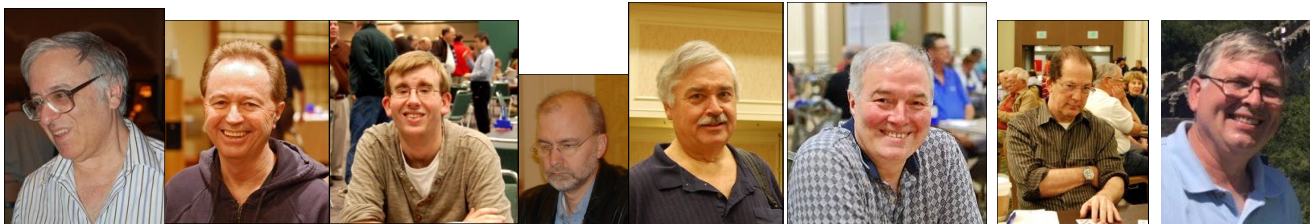

Hand 1: Board 3, Dir S, 6♥ = W

W: Jon Greenspan

E: Phil Benner

N: Jeff Meckstroth

S: David Berkowitz

Hand: ♠ K764, ♥ K63, ♦ 987, ♣ K96

Hand: ♠ 2, ♥ AJ1072, ♦ J10, ♣ AJ852

Hand: ♠ AQJ95, ♥ 9854, ♦ AK6, ♣ 4

Hand: ♠ 1083, ♥ Q, ♦ Q5432, ♣ Q1073

Trick Count: W 0, N 0, E 0, S 0

	W	N	E	S
1♥	P		3♣*	P
3♠*	P		4♠*	P
5♦*	P		6♥	P
	P		P	

John Greenspan submitted this hand from Saturday's 9th round of the Round Robin. It was Greenspan vs Levine.

3C showed shortness and inv+ values  
 3S control showing  
 4S is RKC  
 5D showed 2 keycards

Meckstroth led the D7. With nothing to gain by finessing in diamonds, Jon won the DA and took stock of the situation. With four top side suit winners, it would take some luck to score eight tricks without getting overuffed. It looked like Jon needed to successfully guess which opponent to finesse for the SK and then try to crossruff 7 trump tricks.



Hating to have to commit so early, Jon considered the alternative of first trying to ruff out the SK to establish dummy's spades. If that didn't work, he still had a chance. He played SA, spade ruff, diamond to the king, spade ruff. Everyone followed but the SK did not appear.

Jon continued with the CA, club ruff, diamond ruff, club ruff (Meckstroth following with the king), to reach this position:

Hand 2: Board 3, Dir S, 6♥ = W

W: Jon Greenspan

E: Phil Benner

N: Jeff Meckstroth

S: David Berkowitz

Hand: ♠ K, ♥ K63, ♦ —, ♣ —

Hand: ♠ —, ♥ AJ, ♦ —, ♣ J8

Hand: ♠ QJ, ♥ 98, ♦ —, ♣ —

Hand: ♠ —, ♥ Q, ♦ 52, ♣ Q

Trick Count: W 0, N 9, E 0, S 0

	W	N	E	S
1♥	P		3♣*	P
3♠*	P		4♠*	P
5♦*	P		6♥	P
	P		P	

On the SQ, David thought for some time before throwing the CQ. Jon ruffed with the HJ, cashed the HA and led a club to elope with dummy's H9 for his 12<sup>th</sup> trick. 9 out of the 12 declarers in the heart slam went down.

Jon was the only one of the three who succeeded without taking a spade finesse.

Greenspan relates, "13 IMPs vs the Levine team was a bright spot in an otherwise disappointing day two."

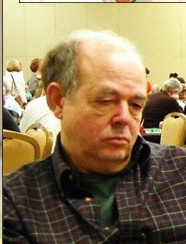
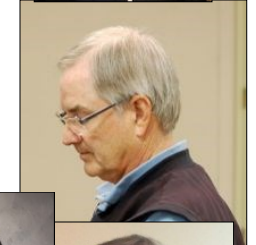
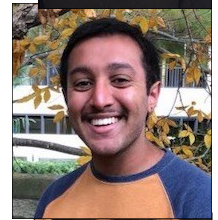



# Meet the Players!

**Jim Fox** has been a bridge player for over 55 years. On his Bridge Winners profile, he says it's "hard to believe I don't play better".

He took several years off for family and work.

He is now living in Virginia Beach.

Jim is the father of two grown children and four wonderful granddaughters (who don't play bridge but are all super softball players).

Jim categorizes himself as a "professional computerist (everything EXCEPT electronics and hardware engineering) for over 50 years and still counting."

He studied Physics, Applied Mathematics, and Business Administration.

## Bridge Information

### *Favorite Bridge Memory*

World Rosenblum Teams - Orlando, FL

### *Bridge Accomplishments*

Overall in WBF Rosenblum Teams, National Open Swiss Teams (multiple), Senior Swiss Teams, and Mixed BAM (multiple); Many Regional A, Open, and Bracket 1 Teams and Pairs wins.

### *Regular Bridge Partners*

and favorite bridge partner - my wife.

### *Favorite Tournaments*

Philadelphia, Orlando and Lille World Series, New Orleans, San Francisco and Washington Nationals, Cambridge, and Virginia Beach Regionals.

### *Favorite Conventions*

Puppet over 1N, Exclusion Blackwood, Delayed Splinters, Michaels, Unusual NT

### *BBO Username*

mmbridge.

In the JLall5 Teams event, Jim is the captain of the Fox team, playing in partnership with Jerry Helms.

I Googled "how to start a wildfire"

I got 48,500 matches

A patient bursts into a doctor's office, "Doctor, I believe I'm a deck of cards!"

The doctor calmly replies, "Go sit in the waiting room, please, I'll be dealing with you later."

The gravity joke is getting old but I fall for it every time!



Hand 1: ♠ KQJ1085, ♥ K108, ♦ QJ, ♣ 105. N Bill Hall

Hand 2: ♠ —, ♥ AJ43, ♦ AK987654, ♣ 3. W Amber Lin

Hand 3: ♠ A973, ♥ 765, ♦ 32, ♣ AKQ4. E Emma Kolesnik

Hand 4: ♠ 642, ♥ Q92, ♦ 10, ♣ J98762. S Joe Viola

Stokes Reynolds

W	N	E	S
1♦	1♠	3NT	P
4♦	P	4♠	P
4NT	P	5♥	P
5♠	P	6♣	P
7♦	P	P	P

Only two pairs, in two different matches, found the grand slam on Board 36 from 12th round.

In the Reynolds/Stokes match, Amber Lin opened 1D with the West hand. Bill Hall overcalled 1S and Emma Kolesnik jumped to 3NT. Lin's 4D bid was a slam try. Kolesnik cuebid 4S and Lin bid RKC. Emma showed two keycards and Amber made a grand slam try by bidding 5S. Emma showed her CK and Lin could count twelve tricks. If Kolesnik held the SK, HK or CQ, there would be thirteen tricks. Lin bid 7D. The SK was led and when trumps broke, there were thirteen easy tricks. Note that a club lead would defeat 7D, but there were always thirteen tricks in NT. Thirty pairs played in a diamond game or slam and a high spade was led at twenty-nine tables.

Hand 1: ♠ KQJ1085, ♥ K108, ♦ QJ, ♣ 105. N Frank Merblum

Hand 2: ♠ —, ♥ AJ43, ♦ AK987654, ♣ 3. W John McAllister

Hand 3: ♠ A973, ♥ 765, ♦ 32, ♣ AKQ4. E Lilly Justman

Hand 4: ♠ 642, ♥ Q92, ♦ 10, ♣ J98762. S Walter Lee

Bauer/Lusky

W	N	E	S
1♦	1♠	3NT	P
5♣	P	6♣	P
7♦	P	P	P

In the Bauer/Lusky match, John McAllister and Lilly Justman had a shorter auction to reach the grand slam. After 1D-1S-3NT, McAllister jumped to 5S (presumably intended as Exclusion Keycard). Justman showed one ace outside the spade suit and McAllister bid the grand, hoping that Justman's balanced 3NT hand would cover his heart losers.

Interestingly, in both of these matches, the opponents stopped in 5D at the opposing table, therefore, simply bidding the small slam would have gained 13 IMPs, while the grand slam gained 17 IMPs... Are 4 IMPs worth the risk?

The extra 4 IMPs creates about a 1 Victory Point gain. If the grand slam is defeated, the net loss is 25 IMPs (losing 12 IMPs instead of winning 13 IMPs for the small slam). This is a cost of about 8 Victory Points. Maybe that's why Barry Crane was quoted to say "Never bid a grand slam in Swiss Teams".

Hand 1: ♠ KQJ1085, ♥ K108, ♦ QJ, ♣ 105. N Pam Wittes

Hand 2: ♠ —, ♥ AJ43, ♦ AK987654, ♣ 3. W Randy Howard

Hand 3: ♠ A973, ♥ 765, ♦ 32, ♣ AKQ4. E Hank Youngerman

Hand 4: ♠ 642, ♥ Q92, ♦ 10, ♣ J98762. S Shawn Quinn

Stokes Reynolds

W	N	E	S
5♦	P	P	P

Hand 1: ♠ KQJ1085, ♥ K108, ♦ QJ, ♣ 105. N Tracey Bauer

Hand 2: ♠ —, ♥ AJ43, ♦ AK987654, ♣ 3. W Allan Falk

Hand 3: ♠ A973, ♥ 765, ♦ 32, ♣ AKQ4. E John Lusky

Hand 4: ♠ 642, ♥ Q92, ♦ 10, ♣ J98762. S Nicolas Hammond

Bauer/Lusky

W	N	E	S
1♦	1♠	2♣	2♠
3♥	3♠	X	P
5♦	P	P	P

# Some Suggestions For Dining at Home Between Sessions! Pandemic Pleasures...

## Belgium Waffles

### Ingredients

- ½ C (115 g) butter
- ¾ C (70 g) sugar
- 1 tsp (5 g) vanilla extract
- Pinch of salt
- 3 lg eggs, separated
- 2 C (250 g) flour
- ¼ tsp (1 g) baking powder
- 1 C (237 ml) milk
- ½ C (120 ml) sparkling water
- Strawberries and whipped cream to taste

### Directions

Preheat waffle maker. In a large bowl, beat together butter, sugar, vanilla extract and salt until well blended and creamy. Add egg yolks; beat until foamy. Stir in flour and baking powder; mix well. Stir in milk and sparkling water. In another large bowl, beat egg whites with an electric mixer until stiff peaks form. Gently fold egg whites into batter. Working in batches, pour mixture into waffle machine and cook until golden brown. Serve with strawberries and whipped cream.

- **Prep time: 15 minutes.**
- **Cook time: 25 minutes or follow the machine's instructions..**
- **Makes 4–6 servings.**

*(Recipes, Continued on page 9)*

Ed. Note:

With the delayed broadcasting and the use of the Round Robin, it will be especially challenging to write up the hands. If anyone has a hand of interest, please submit it to me at [stansubeck@prodigy.net](mailto:stansubeck@prodigy.net). I also welcome any human interest stories, news or gossip!!

Thanks.

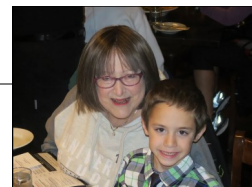

What music do sheep like? Lady Baa Baa and Ed Shearan

What's a sheep's favorite car? A Lamborghini

How do sheep greet each other? "Hay, how's it going?"

What is it called when a sheep wins an election by a huge margin? A lamb slide

What do you call it when a sheep jumps out at you? A lambush!

What do Mexican sheep say during Christmas? Fleece Navidad

What do you call a well-dressed sheep? Glamorous!

What do you call a miserly sheep? A sheeps skate

## Puns You Wool Like

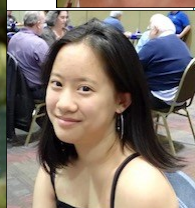
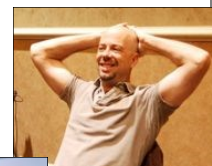



# Shrimp and Crab Wontons

## Ingredients

- ½ C (170 g) finely shredded cabbage, preferably Savoy
- Kosher salt to taste
- 6 oz (170 g) shrimp and lump crabmeat, chopped
- 1 C (50 g) spring onions, finely chopped
- 1 Tbsp (14 g) ginger purée, or finely grated ginger
- 1 tsp (5 g) soy sauce
- 1 tsp (4 g) sesame oil
- 1 Tbsp (15 g) cream cheese
- 1 14-oz (398-g) pkg wonton wrappers
- 2–3 C (473–682 g) vegetable or peanut oil

## Directions

Combine cabbage, salt, shrimp and crab, onions, ginger, soy sauce, sesame oil and cream cheese in a bowl and mix well. Separate wonton wrappers and arrange on a dry surface. Place a scant tsp of filling in center of each wrapper; wet edges and seal by bringing opposite corners together, forming a triangle. Bring 2 remaining corners together toward center and seal with a pinch.

Preheat oil in a medium saucepan over medium heat. Working in batches, fry wontons until golden brown, about 6 minutes. Remove with a slotted spoon and transfer to paper towels. Serve hot with your favorite dipping sauce, such as hoisin; sweet and sour or Chinese mustard.

- **Prep time: 22 minutes.**
- **Cook time: 36 minutes.**
- **Makes 8 servings.**

*(Recipes, Continued on page 10)*

I.T. is one of the biggest sheep industries. There's always a need for more RAM.

Where did the sheep like to watch videos? Ewe Tube

Two sheep were talking about a ewe. They were trying to figure out if they'd met herbivore.

What's the sheep's motto? All's wool that ends wool.

What is a sheep's favorite film? Rambo

**More Un"herd"  
Of Puns!**



# Beer Battered Walleye

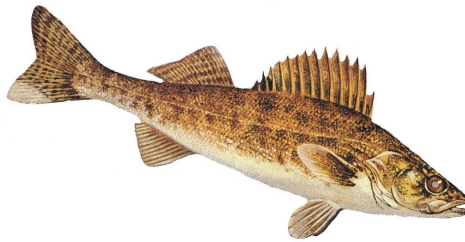

## Ingredients

### SAUCE

- 1 Tbsp (14 g) butter
- ¼ C (40 g) onion, minced
- ½ tsp (1.25 g) red pepper flakes
- ¼ tsp (0.5 g) dry mustard
- ¼ tsp (0.5 g) paprika
- ¼ C (60 ml) apple cider vinegar
- ½ C (118 ml) chicken stock
- 12 oz (355 ml) bottle beer
- Salt and pepper to taste
- 1 Tbsp (12 g) sugar
- 1 tsp (2.5 g) corn starch

### FISH

- Oil for frying
- ¾ C (96 g) flour
- Salt and pepper to taste
- ¼ tsp (0.5 g) dry mustard
- ½ C (118 ml) beer
- 1 lb (0.5 kg) walleye fillets, cut into finger-size segments

## Directions

### SAUCE

Heat butter over medium high; add onion and red pepper flakes. Sauté until onion is translucent and soft, 6–8 minutes. Add dry mustard, paprika, vinegar, chicken stock, beer, and salt and pepper to taste. Cook until reduced by two-thirds. Add sugar and cook for 1 more minute. Using a fork or whisk, mix corn starch with 1 tsp cold water, add to sauce, stir until thickened; set aside.

### FISH

In a fryer or deep pan, heat oil to 375°F (190°C). Combine flour, salt and pepper, dry mustard, and beer until you have a pancake-like batter. Dip fish in batter and cook in batches until golden brown, 2–3 minutes; drain on paper towels.

### PLATING

Serve immediately, using the sauce for dipping.

- **Prep time: 10 minutes.**
- **Cook time: 45 minutes.**
- **Makes 3 servings.**

What do you get when you cross a sheep and a rhino?  
A ewenicorn

What do you call a rumor among sheep?  
Herd it through the grapevine



What paperwork do elderly sheep need?  
Their last wool and testament

What did the sheep parent say to the little lambs?  
“I want everything cleaned up and sheep-shape!”

The sheep family was finally able to get together again after the pandemic. It was a real re-ewe-nion.

7		1		9	2			
	2				5		7	
						8		
					9		5	4
	3		2					6
4								8
					8	3		1
			3				6	
		6	4					

# Sudoku

## Answers on Page 16

Sudoku 2

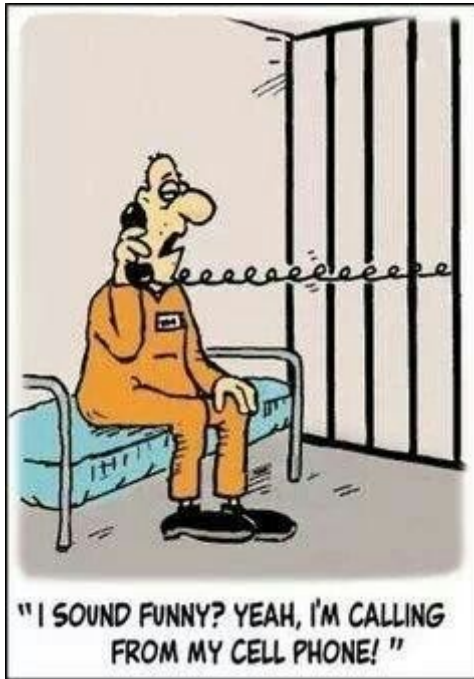

	9	6						
							2	4
						7		
3			5			1		6
			4	1				8
5	8				9		4	
4				3	2		6	
				8				7
7							9	

A guy was admitted to hospital with 8 plastic horses in his stomach.

His condition is now stable.



**SOLUTION to Logic  
Puzzle on page 14**



Havarti	Matzo	Kelly	10:00am
Feta	Rye bread	Isabel	9:30am
Gorgonzola	Wheat bread	Yvette	9:00am
Limburger	Pumpernickel	Brandi	8:30am
Blue cheese	Challah	Candice	8:00am

# Limey Jack...

Oyez Colonials:

Limey Jack is on fire whilst Howie Dung can't find the marmalade with a hound's assistance. Let Limey Jack allow you to take the measure of your favourite punter for a few quid.

Ten squads remain in RR2 yet there are but six settees in which they may be ensconced.

Lewis, Baseggio, Donner and Hill have the clear edge, while Tebha and Lusky come from behind at the 16<sup>th</sup> pole to join them.

More on the morrow.

Ta

Off you are going to Round Robin Two!  
Six will survive when play time is through!

Jack thought that four teams would leave from the site!  
But in a Pandemic, they're home day and night!

On Lewis, on Donner, on Franco, on Hill...  
Enough carryover combined with your skill...

**Howie Doing**

On Lusky for certain, you're bound to remain.  
As to Tebha or Stokes... who's loss is who's gain?

It's said: "different Stokes for different folks" ...  
Some will choose Pepsis and some will choose Cokes!

If Stokes plays in tempo and picks up the pace,  
They'll Q by a nose to score up 6th place!

## Helpful Information from RealBridge Personnel:

RealBridge has suggested that there are some problems caused by current Apple systems, and have given us instructions on what to do about them; you can ignore this if you're on a PC or an Android tablet:

If you are using a Macintosh computer with the Monterey OS, or Safari 15, and have had problems, please look at [this link](https://realbridge.online/media-support-macos-monterey.htm). <https://realbridge.online/media-support-macos-monterey.htm>

If you are using an iPad that is running IOS 15, think you're an expert user, and are having problems, please look at [this link](https://realbridge.online/settings-change-ios-15.html). <https://realbridge.online/settings-change-ios-15.html>

If you are using an iPad that is running IOS 15, don't think you're an expert user, and are having problems, please look at [this link](https://realbridge.online/media-support-ios-15.html#ios_15_2_update). [https://realbridge.online/media-support-ios-15.html#ios\\_15\\_2\\_update](https://realbridge.online/media-support-ios-15.html#ios_15_2_update)

# Fun and Games Page

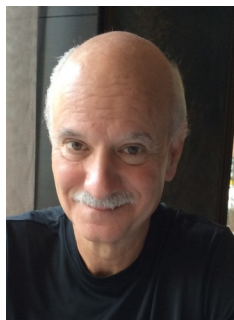
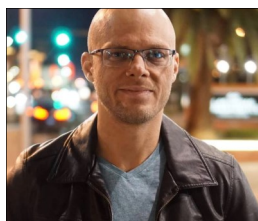

## Pizza

Find and circle all of the pizza ingredients and toppings that are hidden in the grid.  
The remaining letters spell four additional pizza toppings.

```

B A O N T L P O S E O T A M O T C H
A K O G I O Y E N A S E M R A P V I
C E C S A S M O P S U S C R T S H I
O C A A T I L A K P H S T E E N M Z
N B S E J O S M T R E I A V F O E U
G A R O V Y R A I O C R I G Z I S C
O S T O N B E M T H S L O Z E L M C
A A R L O E P R O N O A A N S O O H
T P L I L M P K E K A R U N I C O I
C R S M I A E A C T E L O C R C R N
H I C A V H P A L L N I P U E O H I
E C I L E P L I L A N O S G N R S G
E O L A O B L A E O J T M A G B U O
S T R S I F E E B D N U O R G E M U
E T A P L P B L A S P A R A G U S D
S A G S R E P P E P A N A N A B E A
S P I N A C H G R E E N O L I V E S
    
```

- |                  |              |               |              |
|------------------|--------------|---------------|--------------|
| ARTICHOKE HEARTS | CRUST        | JALAPENOS     | PROVOLONE    |
| ASIAGO           | EGGPLANT     | MONTEREY JACK | RICOTTA      |
| ASPARAGUS        | FETA         | MOZZARELLA    | SALAMI       |
| BACON            | GARLIC       | MUSHROOMS     | SAUSAGE      |
| BANANA PEPPERS   | GOAT CHEESE  | OLIVE OIL     | SHRIMP       |
| BASIL            | GOUDA        | ONIONS        | SPINACH      |
| BELL PEPPERS     | GREEN OLIVES | OYSTERS       | TOMATO SAUCE |
| BLACK OLIVES     | GROUND BEEF  | PARMESAN      | TOMATOES     |
| BROCCOLI         | HAM          | PEPPERONI     | ZUCCHINI     |

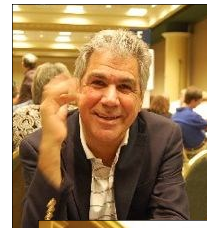

Two handy cards:  
The ace of spades and the proof of Vaccination!

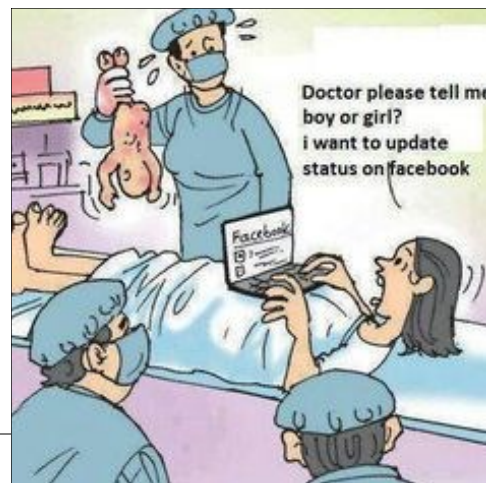
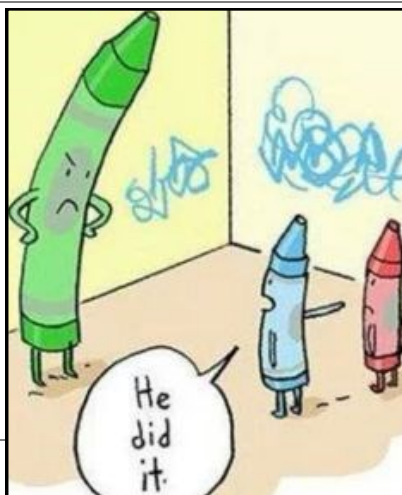

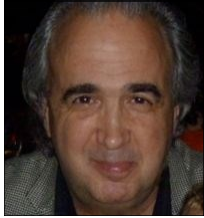

# Logic Puzzle

		Customers					Breads				Cheeses					
		Brandi	Candice	Isabel	Kelly	Yvette	challah	matzo	pumpnickel	rye bread	wheat bread	blue cheese	feta	gorgonzola	havarti	limburger
Times	8:00am															
	8:30am															
	9:00am															
	9:30am															
	10:00am															
Cheeses	blue cheese															
	feta															
	gorgonzola															
	havarti															
	limburger															
Breads	challah															
	matzo															
	pumpnickel															
	rye bread															
	wheat bread															



**Answer  
on  
Page 11**

Times	Customers	Breads	Cheeses
8:00am			
8:30am			
9:00am			
9:30am			
10:00am			

- Yvette came in sometime before the customer who asked for havarti..
- Of Isabel and the customer who ordered matzo, one ordered havarti and the other came in at 9:30am..
- Yvette didn't order challah..
- The customer who came in at 9:00am didn't request blue cheese..
- Isabel didn't request blue cheese..
- Kelly ordered havarti..
- Brandi didn't request blue cheese..
- The person who ordered pumpnickel came in one hour before the customer who ordered rye bread..
- Yvette didn't request limburger..
- Of the person who asked for limburger and the person

who ordered challah, one came in at 8:30am and the other came in at 8:00am..

- The customer who came in at 9:30am didn't request gorgonzola..
- Isabel was either the customer who came in at 9:00am or the person who ordered rye bread.





# JLALL5 RR Stage 1 - Round 10 of 15



17

[11] Nickell  
Steve Weinstein & Bobby Levin  
Eric Greco & Geoff Hampson

0

[1] Bacon  
John Bacon & Ken Kranyak  
Alfred Schenker & Bernie Greenspan

Bd	Table 2	Lead	NS	EW	Table 1	Lead	NS	EW	IMP	
11	3NT+3 S	♥3	490		5♦+1 N	♠4	420		2	
12	3♥= E	♦2		140	3♥+1 E	♠3		170	1	
13	3NT+2 N	♠5	660		3NT= N	♠5	600		2	
14	4♥-1 N	♠A		50	4♥-1 N	♠K		50	-	
15	4♠-1 E	♣K	50		3♠= E	♣K		140	5	
16	2♠+2 N	♣K	170		2♠= N	♣K	110		2	
17	2♥-1 W	♥4	50		2♠-1 S	♣8		50	3	
18	4♥= S	♦A	620		4♠= S	♦A	620		-	
19	4♠-1 S	♣A		50	4♠-2 S	♣A		100	2	
20	4♠+1 W	♦J		650	4♠+1 W	♦J		650	-	
<b>Total</b>									<b>17</b>	<b>0</b>

In the last match on Saturday, team Nickell needed to “bring home the BACON” to work its way up to 5th place in its Bracket (where it finished on Sunday) in order to guarantee a berth in the Knockouts.

Look at the match scoring above... It can't have felt good to be “Nickell and Dimed” like this!

It is no wonder that USA1 Bermuda Bowl combined it's USBC win with its win in the Reisinger in Austin last year!

Using Board-a-Match scoring, Nickell scored 8.5 out of a possible 10.

Finishing 5th in the CEO Bracket will afford the Nickell team four days rest before they need to compete in the Knockouts next Friday.

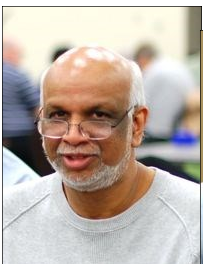
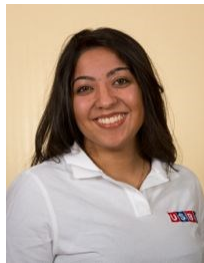

# Puzzle Answers:

5	8	9	7	4	2	7	6	1	3
7	6	7	1	5	3	8	9	8	2
1	2	1	3	8	9	4	7	5	4
8	3	8	6	1	5	9	4	7	9
6	9	6	2	8	4	7	9	1	3
4	1	5	9	3	7	2	8	6	5
9	5	4	6	7	3	8	1	2	9
8	2	3	1	4	5	6	7	9	8
7	6	1	8	9	2	5	4	3	7

**Sudoku**  
**on page 11**  
**Puzzle 1 on left**  
**Puzzle 2 on right**

2	3	6	4	9	1	6	8	7
7	4	1	5	8	9	3	2	6
5	6	5	8	2	7	3	1	4
3	4	3	2	9	6	1	8	5
8	7	8	5	3	4	1	2	9
6	9	6	1	8	5	2	7	3
9	8	9	6	5	2	4	3	1
4	2	4	9	1	3	5	8	7
1	6	2	4	3	9	8	7	5
3	5	1	7	4	8	6	9	2

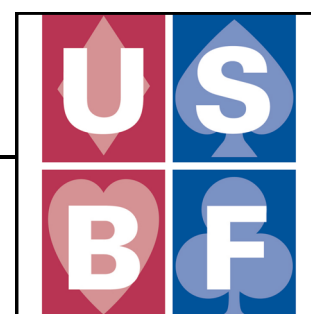

## USBF Supporting Membership

If you don't want to play in the USBF Championships that choose teams to represent the USA in the World Bridge Federation Championships, but do want to aid our events, a **Supporting Membership** can be the perfect way for you to be involved.

A Supporting Membership is \$25 for one year (\$75 for 3 years) and your donation will be used to cover inevitable expenses: attorney fees, accounting fees, website support services, tournament directors, insurance, WBF dues, and vugraph operators.

The USBF is an **all-volunteer** organization.

Our meetings are by conference call and at NABCS. Board members and the organization's officers are not compensated for meetings, travel, or hotel expenses.

We hope you will join us.





Board 23 from Round 11 presented challenges to both the defense and the offense. Every table played in NT from West. Two tables played in 1NT; one table played in 2NT; and the rest found the no-trump game. If North finds the lead of a spade, game is doomed. Nicholas Hammond overcalled an aggressive 1S as a passed hand after the auction went P-1D-P-1H... at his table. His partner, Tracy Bauer, led the SA. Unfortunately for them, hearing the overcall, Levin and Weinstein

disdained the game and stopped in 2NT.

Declarer was able to take four clubs, three diamonds and a spade to succeed.

At the other table in that match, Lilly Justman and John McAllister bid 3NT. Absent an overcall from Katz, Nickell led the CT and McAllister won the king in hand. He played a diamond to the queen and ran the H9 to Nick's jack. Nick had a second shot to shift to spades to defeat the game. Sadly for him, it was anything but clear. Nick continued clubs and McAllister, better late than never, knocked out the HA to take nine tricks.



**Board 23**  
**Dealer S**  
**All Vul**

♠ A107  
♥ AJ3  
♦ J864  
♣ 1096



♠ K4  
♥ Q62  
♦ AK105  
♣ AK73

♠ 963  
♥ K984  
♦ Q97  
♣ Q52

♠ QJ852  
♥ 1075  
♦ 32  
♣ J84

	NT	♠	♥	♦	♣
N	3	6	3	3	3
S	3	6	3	3	3
E	7	6	8	9	9
W	9	6	9	10	10

NS	EW	Contract	Lead	Score
Dennis Dawson & Charlie Wilkins	Jon Greenspan & Phil Benner	3NT-3 W	♣10	300
Jerry Clerkin & John Hinton	Doug Simson & Jeff Aker	3NT-1 W	♣10	100
Bill Hall & Joe Viola	Jessica Lai & Grant Vance	3NT-1 W	♠A	100
Cornelius Duffie & Brent Xiao	Craig Ganzer & Andy Goodman	3NT-1 W	♣10	100
Tracey Bauer & Nicolas Hammond	Bobby Levin & Steve Weinstein	2NT= W	♠A	120
Jerry Helms & Jim Fox	Kevin Dwyer & Joyce Hill	1NT+2 W	♣10	150
Melody Bi & Alan Watson	Meiyan Duan & Yaning Zhou	1NT+3 W	♣10	180
Nick Nickell & Ralph Katz	Lilly Justman & John McAllister	3NT= W	♣10	600
Bill Pollack & Bob Blanchard	Zia Mahmood & Roger Lee	3NT= W	♣10	600
Michael Rosenberg & Vinita Gupta	Fred Stewart & Steve Beatty	3NT= W	♣10	600
Jenni Carmichael & Tom Carmichael	David Yang & Jonathan Weinstein	3NT= W	♠7	600
David Chechelashvili & Ai-Tai Lo	Arthur Gong & Nathan Gong	3NT= W	♣10	600
John Hurd & Kevin Bathurst	Jon Rice & Wayne Stuart	3NT= W	♠7	600
Adam Grossack & Chris Parker	Brian Zhang & Steve Chen	3NT= W	♣10	600
Franco Baseggio & Andy Stark	Emma Kolesnik & Amber Lin	3NT= W	♣9	600
Pam Wittes & Shawn Quinn	Jeff Roman & Ralph Buchalter	3NT= W	♣10	600
Les Bart & Gloria Bart	Jim Krekorian & Drew Casen	3NT= W	♣9	600
John Diamond & Brian Platnick	Mark Aquino & Bob Cappelli	3NT= W	♣10	600
Eric Genheimer & Joe Veal	Brad Moss & Joe Grue	3NT= W	♣10	600
Sandra Rimstedt & Gary Donner	Daniel Weiss & Kyle Rockoff	3NT= W	♣10	600
Farid Assemi & Jim Slinger	Hank Youngerman & Randy Howard	3NT= W	♠7	600
John Bacon & Stelian Hritcu	Chris Willenken & Migry Campanile	3NT+1 W	♣10	630
Eldad Ginossar & Dana Berkowitz	Fred Schenker & Bernie Greenspan	3NT+1 W	♦4	630
Walter Lee & Frank Merblum	Tom Bishel & John Bishel	3NT+1 W	♦4	630
Qiang Zhang & Serena Guo	Joel Wooldridge & David Grainger	3NT+1 W	♦4	630
Eric Xiao & Dawei Qi	Carrie Liu & Maxim Silin	3NT+1 W	♦4	630
Steve Robinson & Peter Boyd	Josh Donn & Ron Smith	3NT+1 W	♦4	630
Paul Lewis & Linda Lewis	Bart Bramley & Kit Woolsey	3NT+1 W	♣9	630
Geof Brod & Pat McDevitt	Mark Itabashi & Disa Eythorsdottir	3NT+1 W	♠7	630
Anam Tebha & Steve Zolotow	Kevin Rosenberg & Cynthia Huang	3NT+1 W	♦4	630
Jane Mclaughlin & Ethan Wood	Mark Lair & Mike Passell	3NT+2 W	♦4	660
Eddie Wold & Mike Levine	Alix Taylor & Peter Boyd-Bowman	3NT+2 W	♣10	660

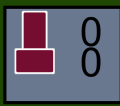
  Bd 23, Dlr S 3NT-1 W	♠ A107 ♥ AJ3 ♦ J864 ♣ 1096	N Cornelius Duffie
	W Andy Goodman	♠ K4 ♥ Q62 ♦ AK105 ♣ AK73
	♠ QJ852 ♥ 1075 ♦ 32 ♣ J84	W N E S P P P P 1♦* P 1♥ P 2NT P 3NT P P P
S Brent Xiao		

In Tebha/Rosenberg, Duffie, like Nickell, led the CT against 3NT. Goodman won the queen in dummy and played a heart to his queen and Duffie's ace. Duffie continued clubs to Goodman's ace and Goodman cashed the DK, played a diamond to the queen, and cashed the DA. When diamonds didn't split 3-3 and the jack did not fall, he had to scramble for a 9th trick.

He played a diamond, letting Duffie win his jack. It was too late for N/S to attack spades so Duffie exited a pedestrian club. Goodman won the CK and cashed the C7. All would have been well and good at this point had Goodman seen fit to discard a spade rather than a heart from dummy. At the table, he discarded the H8 and look what happened... He played the H2 toward dummy's K9 and Duffie, sensing an endplay, hopped with his jack. Goodman won the king and was helpless. Instead of Duffie being endplayed, dummy was endplayed. If Goodman left dummy with the H9, Xiao would win his ten and play the SQ through the king to defeat the contract. If Goodman played a spade off dummy, it would produce the same result! Contract failing one trick!

As pointed out earlier, had Dummy discarded a spade instead of the heart on the ultimate club, dummy would hold the HK9 and with hearts dividing 3-3, the H9 would become declarer's ninth trick!

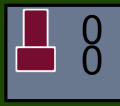

Benner suffered the worst fate as declarer. Dawson led the CT; Benner won dummy's queen. Benner played a heart to the queen and ace and Dawson continued clubs to Benner's ace. Benner played three rounds of high diamonds ending in his hand. He cashed the CK and played the H6 to Dawson's H3, dummy's H8 eight and Wilkins's ten!! Wilkins played the SQ through declarer's K4 to defeat the contract THREE tricks!!

Benner could have brought home nine tricks. To do this, he needs to cash his last club while in hand, discarding a spade from dummy. He can play a small heart toward dummy. If Dawson plays small, declarer must win the HK and exit with a heart to North's jack. Dawson can cash a diamond, but then he is endplayed in spades! If Dawson inserts the HJ on the second round of the suit, declarer must duck the HJ. Dawson will cash his diamond with dummy discarding a spade. But in the end, North will still be endplayed into giving declarer a ninth trick.

  Bd 23, Dlr S 3NT-3 W	♠ A107 ♥ AJ3 ♦ J864 ♣ 1096	N Dennis Dawson
	W Phil Benner	♠ K4 ♥ Q62 ♦ AK105 ♣ AK73
	♠ QJ852 ♥ 1075 ♦ 32 ♣ J84	W N E S P P P P 1♦* P 1♥ P 2NT* P 3NT P P P
S Charlie Wilkins		

This hand was complex in the bidding and play at many tables. It is a good example of why true students of the game return over and over looking for that perfect epiphany!

On this hand, in summary, the defenders could defeat the game themselves, or, if the defenders miss the boat, declarer might still fail on their own!!



N Meiyuan Duan

Bd 70, Dlr E  
 4♠-1 W

W Walter Lee
Frank Merblum E

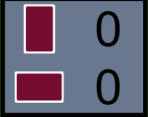
♠ 1073 ♥ 7653 ♦ 10642 ♣ Q4	♠ QJ2 ♥ KQ4 ♦ AKQ5 ♣ J97
♠ K8654 ♥ 98 ♦ 9 ♣ A8632	♠ A9 ♥ AJ102 ♦ J873 ♣ K105



W	N	E	S
		1♦	P
1♠	P	2NT	P
3♥*	P	3♠	P
3NT	P	4♠	P
P	P		



Yaning Zhou S

On the last hand of Round-Robin 1, twenty nine pairs found their way to 4S, a contract that can only be made on a defensive slip.

The easiest defense is for North to lead a heart to South's ace and South to guess to shift to a club. Declarer ducks the club. North wins the queen and continues clubs.

If South does not find the club shift and just continues hearts, the hand can still be defeated as long as the defenders play carefully.

On careful defense, declarer will eventually lose one trump, one heart and two club tricks. That was what happened at Walter Lee's table in the Xaio/Lusky match.



N Jeff Aker

Bd 70, Dlr E  
 3NT= E

W Dawei Qi
Eric Xiao E

♠ 1073 ♥ 7653 ♦ 10642 ♣ Q4	♠ QJ2 ♥ KQ4 ♦ AKQ5 ♣ J97
♠ K8654 ♥ 98 ♦ 9 ♣ A8632	♠ A9 ♥ AJ102 ♦ J873 ♣ K105



W	N	E	S
		1♦	P
1♠	P	2NT	P
3♣*	P	3♦*	P
3NT	P	P	P

Doug Simson S

At the other table, apparently due to some conventional confusion, Eric Xiao and Dawei Qi found their way to the unbeatable 3NT contract!!

The 3C bid was described as asking about spades and the 3D response was described as forced. It looks like Qi presumed that 3D denied 3-card spade support. When confusion sets in, Bob Hamman's rule is to bid 3NT to end the auction! It was a good rule here!

Doug Simson led the HT to declarer's king. Xiao played the SQ. Simson won and exited with a spade. Declarer won the spade and claimed nine tricks!!

12 IMPs to Xiao

✉ ✍ **♠ K987** N Kevin Rosenberg  
**Bd 66, Dir E** **♥ QJ873**  
**7♦ = E** **♦ —**  
**W Ron Smith** **♣ 9763** **E Josh Donn**  
**♠ 5** **♠ AQJ3**  
**♥ AK965** **♥ —**  
**♦ K1097** **♦ AQ654**  
**♣ AQ8** **♣ J1042**

W	N	E	S
1♥	P	1♦	P
2♣*	P	3♣	P
3♦	P	3♠	P
4♣	P	4♦	P
4♥*	P	5♦*	P
5♠	P	7♦	P
P	P	P	P

0 **♠ 10642**  
0 **♥ 1042**  
< > **♦ J832**  
**Ish DelMonte S** **♣ K5**

Josh Donn and Ron Smith took eight rounds of bidding to reach the grand slam on Board 66 of the Lewis/Rosenberg 15<sup>th</sup> round match. The Rosenberg team, mostly Junior players, won this match and took 1<sup>st</sup> place in their Round-Robin bracket. They have successfully advanced to the Knockout Stage. The Lewis team will be continuing in the 2<sup>nd</sup> Round-Robin on Monday.

The auction was straightforward: 2C was fourth suit forcing; 4H was kickback for diamonds; and 5D showed two keycards and the DQ.

Del Monte led the H2. Dummy followed small and Kevin Rosenberg false-carded with the HQ. Donn trumped and cashed the DA. Given the bad trump split, it looked like the club finesse would be needed. Donn led the CJ, DelMonte played the CK and dummy won the CA. Donn trumped a second heart and cashed the DQ. Rosenberg discarded spades on both rounds of trumps. He knew he needed to guard both hearts and clubs. Donn played a diamond to the ten and Rosenberg discarded another spade. Donn cashed the DK and Rosenberg discarded the SK. Declarer claimed thirteen tricks.

In the other room Cornelius Duffie and Brent Xiao stopped in 6D and took an easy thirteen tricks when a spade was led, picking off North's SK.

11 IMPs to Lewis.

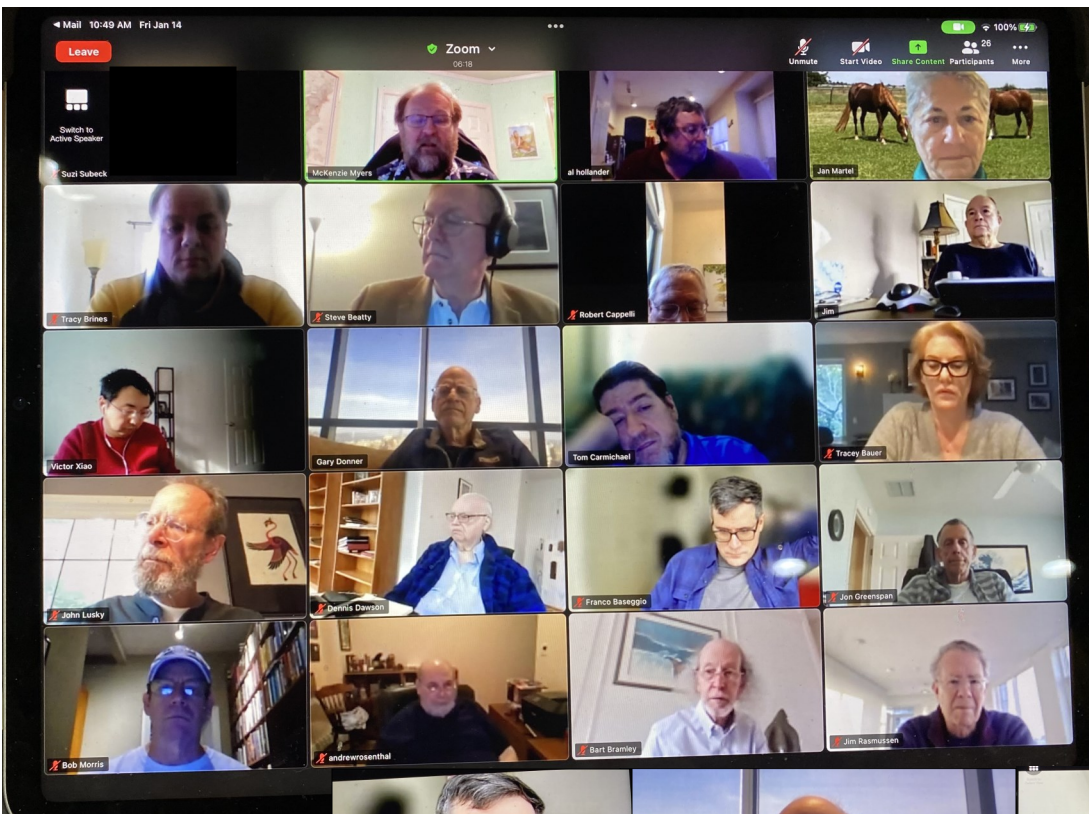

**At  
The  
Captain's  
Meeting  
on  
Friday  
Morning!**

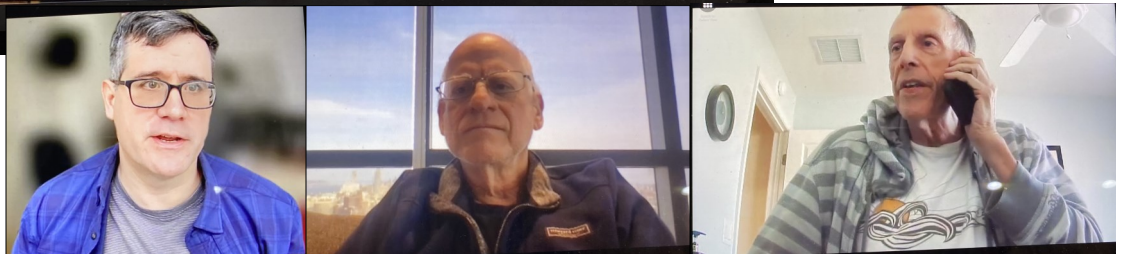

**jlall5 - Round Robin Stage 1 (thru R15 possible boards = 150)**

<b>played at least 40% of boards</b>				
<b>rank</b>	<b>partnership</b>	<b>total imps</b>	<b>#boards</b>	<b>avg</b>
1	Anton Tsytkin - Jim Rasmussen	103.63	100	1.04
2	David Yang - Jonathan Weinstein	103.48	100	1.03
3	Kevin Dwyer - Shan Huang	74.88	80	0.94
4	Andy Stark - Franco Baseggio	97.91	110	0.89
5	Bart Bramley - Kit Woolsey	115.64	130	0.89
6	Brent Xiao - Cornelius Duffie	75.62	90	0.84
7	Dawei Qi - Eric Xiao	81.74	100	0.82
8	Finn Kolesnik - Ish DelMonte	56.54	70	0.81
9	Anam Tebha - Steve Zolotow	71.22	90	0.79
10	Michael Rosenberg - Zach Grossack	70.93	90	0.79
11	David Berkowitz - Jeff Meckstroth	79.27	120	0.66
12	Josh Donn - Ron Smith	98.67	150	0.66
13	Dana Berkowitz - Eldad Ginossar	61.57	100	0.62
14	John Hurd - Kevin Bathurst	91.89	150	0.61
15	Cynthia Huang - Kevin Rosenberg	59.71	100	0.60
16	Peter Boyd - Steve Robinson	70.10	120	0.58
17	Daniel Weiss - Kyle Rockoff	56.92	100	0.57
18	Drew Casen - Jim Krekorian	50.55	120	0.42
19	Andrew Rosenthal - Debbie Rosenberg	37.58	100	0.38
20	Alfred Schenker - Bernie Greenspan	37.56	100	0.38
21	Alan Watson - Melody Bi	37.02	100	0.37
22	Disa Eythorsdottir - Mark Itabashi	41.41	120	0.35
23	Janice Molson - Sandra Rimstedt	19.23	60	0.32
24	Jon Rice - Wayne Stuart	29.72	100	0.30
25	John Bacon - Ken Kranyak	20.77	70	0.30
26	Ai-Tai Lo - David Chechelashvili	28.64	100	0.29
27	Brad Moss - Joe Grue	40.99	150	0.27
28	Adam Grossack - David Grainger	15.79	60	0.26
29	Bobby Levin - Steve Weinstein	24.66	100	0.25
30	Ifti Baqai - Mitch Dunitz	24.20	100	0.24
31	Doug Simson - Jeff Aker	21.49	100	0.21
32	Daniel Korbel - Roger Lee	18.13	90	0.20
33	Alix Taylor - Peter Boyd-Bowman	16.95	89	0.19
34	Christal Henner - Uday Ivatury	20.89	110	0.19
35	Nick Nickell - Ralph Katz	16.96	90	0.19
36	Chris Willenken - Migry Campanile	18.83	100	0.19
37	Hemant Lall - Reese Milner	12.88	70	0.18
38	Eric Greco - Geoff Hampson	19.89	110	0.18
39	Meiyan Duan - Yaning Zhou	10.15	100	0.10
40	Jenni Carmichael - Tom Carmichael	15.18	150	0.10
41	Allan Graves - Neil Chambers	9.09	110	0.08
42	Fred Stewart - Steve Beatty	8.16	100	0.08
43	Lance Kerr - Tom Reynolds	4.05	80	0.05
44	Adam Grossack - Chris Parker	4.03	90	0.04
45	Eddie Wold - Mike Levine	1.42	70	0.02

(continued on page 22)

46	Doug Doub - Yiji Starr	1.82	100	0.02
47	Pam Wittes - Shawn Quinn	1.75	100	0.02
48	Frank Merblum - Walter Lee	-4.49	100	-0.04
49	Carrie Liu - Maxim Silin	-4.70	100	-0.05
50	Mark Lair - Mike Passell	-9.57	110	-0.09
51	Cheri Bjerkan - Rozanne Pollack	-9.64	100	-0.10
52	Charlie Wilkins - Dennis Dawson	-8.62	80	-0.11
53	Bill Hall - Joe Viola	-13.86	110	-0.13
54	Glenn Eisenstein - John Rengstorff	-12.24	90	-0.14
55	Brian Platnick - John Diamond	-15.22	110	-0.14
56	John McAllister - Lilly Justman	-21.17	150	-0.14
57	Gary Donner - Sandra Rimstedt	-14.42	90	-0.16
58	Alex Kolesnik - Steve Price	-15.14	80	-0.19
59	Jon Greenspan - Phil Benner	-19.93	100	-0.20
60	Joyce Goldstein - Tracy Brines	-20.22	100	-0.20
61	Ethan Liu - Jun Shi	-18.34	90	-0.20
62	Jerry Clerkin - John Hinton	-39.13	150	-0.26
63	Bob Cappelli - Mark Aquino	-40.32	150	-0.27
64	Amber Lin - Emma Kolesnik	-25.01	80	-0.31
65	Allan Falk - John Lusky	-32.85	100	-0.33
66	Jeff Roman - Ralph Buchalter	-38.30	110	-0.35
67	John Bishel - Tom Bishel	-56.04	150	-0.37
68	Gloria Bart - Les Bart	-60.48	150	-0.40
69	Andy Goodman - Craig Ganzer	-48.08	100	-0.48
70	Farid Assemi - Jim Slinger	-48.10	90	-0.53
71	JoAnna Stansby - Li-Chung Chen	-54.22	100	-0.54
72	Edward Wojewoda - Ieszek Rabiega	-66.10	120	-0.55
73	Hank Youngerman - Randy Howard	-61.39	110	-0.56
74	Grant Vance - Jessica Lai	-51.80	90	-0.58
75	Arthur Gong - Nathan Gong	-92.06	150	-0.61
76	Linda Lewis - Paul Lewis	-93.81	150	-0.63
77	Geof Brod - Pat Mcdevitt	-50.46	80	-0.63
78	Joel Wooldridge - Stewart Rubenstein	-63.99	100	-0.64
79	Bill Pollack - Bob Blanchard	-72.15	100	-0.72
80	Eric Genheimer - Joe Veal	-54.95	70	-0.79
81	Ethan Wood - Jane Mclaughlin	-79.86	100	-0.80
82	Jeff Xiao - Victor Xiao	-68.89	80	-0.86
83	Jerry Helms - Jim Fox	-78.59	90	-0.87
84	John Bacon - Stelian Hritcu	-77.86	80	-0.97
85	Chris Donnelly - Sarik Goyal	-132.11	112	-1.18
86	Nicolas Hammond - Tracey Bauer	-181.17	150	-1.21
87	Joyce Hill - Kevin Dwyer	-93.38	70	-1.33
88				

(continued from page 21)